

POWERTOOLS

BRÜDER
MANNESMANN[®]
WERKZEUGE



POWERTOOLS

Werkzeuge für

DIY • Handwerk • Industrie

Inhaltsverzeichnis



Akkugeräte

Präzisions Akkuschauber	1
Akku Stab- Pistolenschrauber	2
Akku Bohrschrauber	2 - 4
Werkzeugkoffer mit Akku Bohrschrauber	5 - 6
Toolbag, Akku Bohrschrauber mit Akku Stichsäge & Zubehör	8
Akku Bohr- und Meißelhammer	7
Akku Stichsäge	8
Akku Gartensäge	9
Akku Winkelschleifer	9
Akku Handkreissäge	10
Akku Rotationsschleifer	10
Akku Heißluftgebläse	11
Akku Heißklebepistole	11
Akku Nass- und Trockensauger	12



BRÜDER
MANNESMANN
WERKZEUGE GMBH

1. Platz
PREIS / LEISTUNG

IN DER KATEGORIE
BOHRMASCHINEN &
-HÄMMER



Netzbetriebene Geräte

Nass- und Trockensauger	13 - 14
Elektrogerätekofter	15
Werkzeugsatz mit Bohrmaschine	16
Bohrhammer	17 - 18
Bohrschrauber	19
Schlagbohrmaschinen	20
Winkelschleifer	21 - 22
Stichsäge	22
Handkreissäge	23 - 25
Elektrohobel	26
Flachdübelfräse	26
Schwingschleifer	27
Exenterschleifer	28
Bandschleifer	28
Doppelschleifmaschinen	29
Oberfräse	30
Tacker	30
Compact tool • Hobby tool kit	31 - 32
Heißluftgebläse	33
Farb- und Mörtelrührer	34

Präzisions- Akkuschauber

Inhalt:

- 1 x Präzisions- Akkuschauber
- 1 x Ständer mit Bitdepot
- 1 x USB Ladekabel
- 10 x Bits, S2-Stahl
- Schlitz: 1 • 1,5 • 3 mm
- T-Profil: T5 • T6 • T8
- Philips: PH000 • PH00 • PH1
- Innen 6-kant: 2 mm



3,6 V



Precision cordless screwdriver

Content:

- 1 x precision cordless screwdriver
- 1 x stand with bit depot
- 1 x USB charging cable
- 10 x bits, S2 steel
- Slot: 1 • 1.5 • 3 mm
- T-profile: T5 • T6 • T8
- Philips: PH000 • PH00 • PH1
- Inside hexagon: 2 mm



Destornillador inalámbrico de precisión

Contenido:

- 1 x destornillador inalámbrico de precisión
- 1 x soporte con depósito de bits
- 1 x cable de carga USB
- 10 x puntas, acero S2
- Ranura: 1 • 1,5 • 3 mm
- Perfil en T: T5 • T6 • T8
- Philips: PH000 • PH00 • PH1
- Hexágono interior: 2 mm



Art.Nr	EAN-Nummer	Gewicht	VPE	Art
17721	40 03315 84636 9	0,280 kg	20	Karton



- 3,6V Akku- Stabschrauber**
- inkl. 52 Bits und Bithalter
 - 6 Drehmomenteinstellungen
 - Handgriff drehbar, von Pistolen zu Stabschrauber
 - Integrierte Arbeitsleuchte im Griffende
 - Ladezustandsanzeige
 - inkl. Steckernetzgerät

- 3.6V cordless straight screwdriver**
- incl. 52 bits and bit holder

- Destornillador recto inalámbrico de 3,6 V**
- incluye 52 puntas y soporte para puntas

	3,6 V 1300 mAh
	230 min ⁻¹



Art.Nr	EAN-Nummer	Gewicht	VPE	Art
17735	40 03315 84651 2	1,500 kg	8	Kassette

XC-2 Pro Serie

Akku- Bohrschrauber

- Lithium Ionen Akku 12V, 1,3 Ah
- Drehzahl stufenlos elektronisch regelbar
- Akku- Ladezustandsanzeige (LED)
- Ø 10 mm Schnellspann-Bohrfutter
- Integrierte Arbeitsleuchte
- 18-fache Drehmomenteinstellung + 1 Stufe "Bohren"
- 1 Doppelbit am Schrauber
- Anti-Slip Griff

Cordless drill

- Lithium ion battery 12V, 1.3 Ah
- Infinitely variable speed electronically adjustable
- Battery charge status indicator (LED)
- Ø 10 mm quick release drill chuck
- Integrated work light
- 18-fold torque setting + 1 stage „drilling“
- 1 double bit on the screwdriver
- Anti-slip handle

	12 Volt 1300 mAh
	0 - 650 min ⁻¹
	Ø 10 mm

Art.Nr	EAN-Nummer	Gewicht	VPE	Art
17675	40 03315 84829 5	1,200 kg	10	Karton



12V

Destornillador recargable 12 V

- Batería de iones de litio de 12 V, 1,3 Ah
- Velocidad infinitamente variable ajustable electrónicamente
- Indicador de estado de carga de la batería (LED)
- Portabrocas de liberación rápida de Ø 10 mm
- Luz de trabajo integrada
- Ajuste de torque 18 veces mayor + 1 etapa de „perforación“
- 1 punta doble en el destornillador
- Mango antideslizante

XC-2 Pro Serie



20V

Akku-Bohrschrauber 20V

- Lithium Ionen Akku 20V, 1,3 Ah
- Drehzahl stufenlos elektronisch regelbar
- Ø 10 mm Schnellspann-Bohrfutter
- Integrierte Arbeitsleuchte
- 18-fache Drehmomenteinstellung
- + 1 Stufe "Bohren"
- 1 Doppelbit am Schrauber
- Anti-Slip Griff
- Im Aufbewahrungskoffer

20V Cordless battery screwdriver

Destornillador recargable 20 V

	20 Volt 1300 mAh
	0 - 650 min ⁻¹
	Ø 10 mm
	
	

Art.Nr	EAN-Nummer	Gewicht	VPE	Art
17680	40 03315 84823 3	2,300 kg	5	Karton



XC-2 Pro Serie

20V

Akku-Bohrschrauber 20V
mit 2.Akku

- Lithium Ionen Akku 20V, 1,3 Ah
- Drehzahl stufenlos elektronisch regelbar
- Ø 10 mm Schnellspann-Bohrfutter
- Integrierte Arbeitsleuchte
- 18-fache Drehmomenteinstellung
- + 1 Stufe "Bohren"
- 1 Doppelbit am Schrauber
- Anti-Slip Griff
- Im Aufbewahrungskoffer

20V Cordless battery screwdriver
with 2 Li-Ionen batteries

Destornillador recargable 20 V
con 2 Li-ion acumulador

	20 Volt 1300 mAh
	0 - 650 min ⁻¹
	Ø 10 mm
	
	

Art.Nr	EAN-Nummer	Gewicht	VPE	Art
17685	40 03315 84826 4	2,700 kg	5	Karton



XC-2 Pro Serie







20V

Akku-Bohrschrauber 20V
mit 2. Akku
mit 2 Geschwindigkeitsstufen

- 2 Lithium Ionen Akkus 20V, 1,5 Ah
- Drehzahl stufenlos elektronisch regelbar
- 2 umstellbare Geschwindigkeitsstufen
- Ø 10 mm Schnellspann-Bohrfutter
- Integrierte Arbeitsleuchte
- 18-fache Drehmomenteinstellung + 1 Stufe "Bohren"
- 1 Doppelbit am Schrauber
- Anti-Slip Griff
- 1 Stunden Schnellladegerät
- Im Aufbewahrungskoffer

20V Cordless battery screwdriver,
2 - gear , with 2 Li-Ionen batteries

Destornillador recargable 20 V,
con 2 niveles de velocidad,
con 2 Li-ion acumulador

	20 Volt 1500 mAh
	0 - 400 min ⁻¹ 0 -1400 min ⁻¹
	Ø 10 mm
	
	

Art.Nr	EAN-Nummer	Gewicht	VPE	Art
17690	40 03315 84827 1	2,400 kg	5	Karton



Anti-Slip

XC-2 Pro Serie

24V

Akku-Bohrschrauber 24V

- Lithium Ionen Akku 24V, 1,3 Ah
- Drehzahl stufenlos elektronisch regelbar
- Ø 10 mm Schnellspann-Bohrfutter
- Integrierte Arbeitsleuchte
- 18-fache Drehmomenteinstellung + 1 Stufe "Bohren"
- 1 Doppelbit am Schrauber
- Anti-Slip Griff
- Im Aufbewahrungskoffer

24V Cordless battery screwdriver

Destornillador recargable 24 V

	24 Volt 1300 mAh
	0 - 650 min ⁻¹
	Ø 10 mm
	
	

Art.Nr	EAN-Nummer	Gewicht	VPE	Art
17695	40 03315 84828 8	2,600 kg	5	Karton



Anti-Slip



Akku-Bohrschrauber mit 55-tlg. Werkzeugsortiment

- Akku-Bohrschrauber 8 V,
1,3 Ah Li-Ionen Akku
Ø 10 mm Schnellspann-Bohrfutter
- Werkzeugsortiment:
 - 1 x Kombizange 160 mm
 - 2 x Schraubendreher
Schlitz 5 x 75 mm • PH1 x 75 mm
 - 1 x Bandmaß 2 m
 - 1 x Kleinteilesortiment
 - 1 x Schraubgriff für Bits
 - 20 x Bits 25 mm
 - 10 x Bits 50 mm
 - 1 x Magnetischer Bithalter
 - 9 x Steckschlüsseleinsätze 6,3 mm (1/4" 9
5 • 6 • 7 • 8 • 9 • 10 • 11 • 12 • 13 mm
 - 1 x Adapter für Steckschlüsseleinsätze
 - 4 x Holzbohrer 3 • 4 • 5 • 6 mm
 - 4 x Spiralbohrer 1,5 • 2 • 2,5 • 3 mm

55-pcs. Tool Kit with cordless drill 8 V

Maletín de herramientas
de 55 pzas. con
atornillador
recargable electrónico 8 V

**10 mm
Schnellspann-Bohrfutter**



umschaltbarer
Rechts-/Linkslauf

stufenlos regulierbare
Drehzahl und Quickstop

Anti-Slip Griff

8 V
1,3 Ah Li-Ionen Akku



8 Volt



400 min⁻¹



Ø 10 mm

Art.Nr	EAN-Nummer	Gewicht	VPE	Art
17577	40 03315 84617 8	2,700 kg	5	Koffer

75-tlg.
Werkzeugkoffer
mit Akku-Bohrschrauber 20V Li-Ionen

Inhalt:

- 1 Elektronik-Akku-Bohrschrauber, komplett mit 20V Li-Ionen Akku und Steckernetzgerät
- 5 HSS-Bohrer für Stahl: 4 - 5 - 6 - 8 - 10 mm
- 5 HM-Bohrer für Beton: 4 - 5 - 6 - 8 - 10 mm
- 5 Holzbohrer: 4 - 5 - 6 - 8 - 10 mm
- 1 Schraubknarrengriff mit verstellbarem Kopf
- 24 Bits aus gehärtetem Werkzeugstahl
- 1 Magnethalter, verchromt
- 1 Umschaltknarre 12,5 mm (1/2")
- 9 Steckschlüsseleinsätze 6,3 mm (1/4"): 5 - 6 - 7 - 8 - 9 - 10 - 11 - 12 - 13 mm
- 8 Steckschlüsseleinsätze 12,5 mm (1/2"): 10 - 11 - 12 - 13 - 14 - 17 - 19 - 21 mm
- 1 Adapter für 6,3 mm (1/4") Steckschlüsseleinsätze
- 1 Schlitzschraubendreher
- 1 Kreuzschraubendreher
- 1 Bandmaß, 2 m, mit Stopper
- 1 Kombizange 160 mm, mit schwerer Handschutzhülle
- 1 Wasserpumpenzange, 240 mm, durchgestecktes Gewerbe, mit Schutzhülle
- 1 Schlosserhammer, 200 g
- 6 Gabel - Ringschlüssel: 8 - 10 - 12 - 13 - 14 - 17 mm
- 1 Spannungsprüfer, CE-geprüft
- 1 Schrauben- und Dübelsortiment

75-pcs. Tool Kit with
Electronic Cordless
Drill-Driver 20 V

Maletín de herramientas
de 75 pzas. con
atornillador recargable
electrónico 20 V



10 mm
Schnellspann-Bohrfutter



19-fache
Drehmomenteinstellung

umschaltbarer
Rechts-/Linkslauf

stufenlos regulierbare
Drehzahl und Quickstop

Anti-Slip Griff

Kraftvoller
20 Volt
Li-IonenAkku



20 Volt



0 - 650 min⁻¹



Ø 10 mm

Art.Nr	EAN-Nummer	Gewicht	VPE	Art
17578	40 03315 84856 1	5,800 kg	3	Koffer

XC-1 Pro Serie



- Powerpack Bohr- und Meißelhammer
20V 4000 mAh
für kraftvolles Bohren,
Schlagbohren und Meißeln

- Bürstenloser Motor für lange Lebensdauer
- Umschaltbarer Rechts- / Linkslauf
- Integrierte Arbeitsleuchte
- Anti-Slip Griff
- Inkl. 1 SDS-Spitzmeißel,
1 SDS-Flachmeißel
3 SDS-Bohrer 8 • 10 • 12 mm
- Schnellladegerät
- Im Aufbewahrungskoffer

Electronic cordless rotary hammer

Martillo perforador con batería



20V
4000 mAh

0 -
1400 min⁻¹

SDS-plus

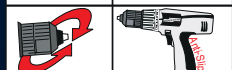

BRÜDER
MANESMANN
WERKZEUGE GMBH
1. Platz
PREIS / LEISTUNG
IN DER KATEGORIE
BOHRMASCHINEN &
-HÄMMER



Art.Nr	EAN-Nummer	Gewicht	VPE	Art
17670	40 03315 71724 9	5,485 kg	3	Karton

Ersatz Li-Ionen Akku • 20V 4000 mAh

Spare battery • 20V 4000 mAh

Acumulador de repuesto • 20V 4000 mAh

Art.Nr	EAN-Nummer	Gewicht	VPE	Art
17671	40 03315 71725 6	0,709 kg	1	Karton



20V Akku-Bohrschrauber

Akku-Werkzeugset in toolbag

- Akkuschrauber +
- Akkustichsäge +
- 1 Akku 20 V +
- 32-tlg. Bitsatz +
- 10-tlg. Sägeblattset +
- Lithium Ionen Akku 20V, 2,0 Ah
- Inklusive 1 Stunden Schnellladegerät
- Drehzahl stufenlos elektronisch regelbar
- In praktischer Reißverschlusstasche

Cordless tool set in toolbag

Juego de herramientas inalámbricas en bolsa de herramientas



Akku-Stichsäge 20 V mit 3-fach Pendelhub



32-tlg. Bitsatz im Etui mit Gürtelclip



10-tlg. Sägeblattset

Art.Nr	EAN-Nummer	Gewicht	VPE	Art
17805	40 03315 84568 3	3,500 kg	4	Karton

20 V Elektronik-Pendelhub-Stichsäge

- 20 V Li-Ionen Akku
- Schnellwechselsystem für Sägeblätter
- 4-fach einstellbarer Pendelhub
- integrierte Arbeitsleuchte
- elektronische Hubzahlregulierung
- Neigbarer Sägeschuh von 45° bis -45°
- Anschluss für Staubabsaugung
- umschaltbare Spanblas-/ Absaugfunktion

Electronic Pendulum Jigsaw with laser beam

- 4-times adjustable pendulum stroke
- infinitely variable number of strokes
- tiltable base plate from 45° to -45°
- laser beam indicates the cutting line
- incl. 3 sawblades (2 x wood, 1 x metal)
- max. cutting depth in wood: 100 mm
- max. cutting depth in NF-metal: 10 mm

Sierra de calar con indicación de corte laser

- 4 ajustes de carreras de penduleo
- base inclinable de 45° hasta -45°
- regulación del número de carreras sin escalones
- el rayo láser indica la conducción del corte
- incluye 3 hojas de sierra (2 para madera, 1 para metal)
- la profundidad de corte para madera es de 100 mm y para acero NF 10 mm



Art.Nr	EAN-Nummer	Gewicht	VPE	Art
17725	40 03315 84620 8	2,200 kg	6	Karton

XC-1 Pro Serie

20V



Akku Winkelschleifer Ø 115 mm

- 20V Li-Ionen Akku, 4,0 AH
- Bürstenloser Motor
- Akku mit Ladestandanzeige 3 LED's
- Einfacher Scheibenwechsel durch Spindelarrretierung
- Verstellbare Schutzhaube
- Zusatzhandgriff an 3 Positionen anschraubbar

Angle Grinder Ø 115 mm

Esmeriladora Angular Ø 115 mm

Schleifscheibe ist nicht im Lieferumfang enthalten. • Disco amolado no incluido! • Grinding disc is not included • Slijpschijf is niet bijgevoegt! • Meule non incluse! La mola per macinare non è compresa nella dotazione. • Brusni Kotač nije dio isporuke.

Art.Nr	EAN-Nummer	Gewicht	VPE	Art
17855	40 03315 84845 5	2,700 kg	6	Karton

12V



12V Li-Ionen Akku Gartensäge

- Lithium Ionen Akku 12V
- Akku - Ladezustandsanzeige
- Schnellladegerät
- Anti-Slip Griff
- Abnehmbarer Haltebügel
- Inkl. 1 Sägeblatt für Holz

12V Li-Ion battery garden saw

- Lithium ion battery 12V
- Battery charge level indicator
- Fast charger
- Anti-slip handle
- Removable bracket
- Including 1 saw blade for wood

Sierra de jardín con batería de iones de litio de 12 V

- Batería de iones de litio 12V
- Indicador de nivel de carga de la batería
- Cargador rápido
- Mango antideslizante
- Soporte extraíble
- Incluye 1 hoja de sierra para madera

Art.Nr	EAN-Nummer	Gewicht	VPE	Art
17792	40 03315 84518 8	1,280 kg	4	Karton

Ersatz Akku zu 12V Li-Ionen Akku Gartensäge Art.Nr.: 17792

- Lithium Ionen Akku 12V

Replacement battery for 12V Li-ion battery garden saw Art.No. : 17792

- Lithium ion battery 12V

Batería de repuesto para sierra de jardín con batería de iones de litio de 12 V Art.No. : 17792

- Batería de iones de litio 12V

Art.Nr	EAN-Nummer	Gewicht	VPE	Art
17793	40 03315 84521 8	0,194 kg	1	Karton



XC-1 Pro Serie

- Akku- Handkreissäge 20V
- 20 V Li-Ionen Akku, 4,0 Ah
 - Bürstenloser Motor
 - Parallelanschlag
 - Anti Slip Griff
 - Spindelarretierung
 - Einstellbare Schnitttiefe
 - Gehrungsschnitte 0° bis 45°
 - HM - Sägeblatt (165 mm x 24T)
 - Vorrichtung zur Staubabsaugung



20V

- Cordless circular saw 20V
- 20 V Li-ion battery, 4.0 Ah
 - Brushless motor
 - Rip fence
 - Anti slip grip
 - Spindle lock
 - Adjustable cutting depth
 - Miter cuts 0° to 45°
 - HM - saw blade (165 mm x 24T)
 - Device for dust extraction

- Sierra circular a batería 20V
- Batería de iones de litio de 20 V, 4,0 Ah
 - Motor sin escobillas
 - Valla cortafuegos
 - Agarre antideslizante
 - Bloqueo del eje
 - Profundidad de corte ajustable
 - Cortes a inglete de 0° a 45°
 - HM - hoja de sierra (165 mm x 24T)
 - Dispositivo para extracción de polvo

Art.Nr	EAN-Nummer	Gewicht	VPE	Art
17860	40 03315 84846 2	4,600 kg	4	Karton

XC-1 Pro Serie

- Akku- Rotationsschleifer
- 20 V Li-Ionen Akku, 2,0 Ah
 - Schleifteller Ø 125 mm
 - Hubzahl 11.000 min⁻¹
 - inkl. Staubfangsack
 - inkl. 1 x Schleifpapier

20V

- Cordless rotary grinder
- 20 V Li-ion battery, 2.0 Ah
 - Sanding pad Ø 125 mm
 - Stroke rate 11,000 min⁻¹
 - Including dust bag
 - incl. 1 x sandpaper

- Amoladora rotativa a batería
- Batería de iones de litio de 20 V, 2,0 Ah
 - Plato lijador Ø 125 mm
 - Frecuencia de carrera 11.000 min⁻¹
 - Incluye bolsa para polvo
 - incl. 1 x papel de lija



20 V



11.000 U/min



Ø 125 mm

Art.Nr	EAN-Nummer	Gewicht	VPE	Art
17845	40 03315 84843 1	1,400 kg	8	Karton

XC-1 Pro Serie

Akku- Heißluftgebläse

- Li-Ionen Akku 20 V, 2,0 Ah
- 2-Stufen Gebläse
- 2 umschaltbare Temperaturbereiche
I = Gebläse kalt
II = max 550° C • 100 l/min
- Inkl. 3 Aufsätzen
1 Punktdüse
1 Breitstrahldüse
1 Kantenschutzdüse
- 1 Schnellladestation



Cordless hot air blower

- Li-ion battery 20 V, 2.0 Ah
- 2-stage fan
- 2 switchable temperature ranges
I = fan cold
II = max 550° C • 100 l / min
- Including 3 attachments
1 point nozzle
1 wide jet nozzle
1 edge protection nozzle
- 1 quick charging station

Pistola de aire caliente inalámbrica

- Batería de iones de litio de 20 V, 2,0 Ah
- ventilador de 2 etapas
- 2 rangos de temperatura conmutables
I = ventilador frío
II = máx 550° C • 100 l / min
- Incluye 3 archivos adjuntos
Boquilla de 1 punto
1 boquilla de chorro ancha
1 boquilla de protección de bordes
- 1 estación de carga rápida



Art.Nr	EAN-Nummer	Gewicht	VPE	Art
49530	40 03315 84774 8	0,600 kg	4	Karton

3,6V Akku- Heißklebepistole

- klebt Papier, Pappe, Kunststoff, Holz, Leder, Textilien, Keramik, Porzellan, Glas, Stein, Metall usw
- Lithium Ionen Akku 3,6 V, 1500 mAh
- Aufheizzeit ca. 15 sek
- Incl. 5 Klebesticks 150 x Ø 7 mm
- Integrierte Arbeitsleuchte
- automatische Abschaltung
- Incl. Steckernetzgerät



3.6V cordless hot glue gun

- sticks paper, cardboard, plastic, wood, Leather, textiles, ceramics, porcelain, Glass, stone, metal, etc.
- Lithium ion battery 3.6 V, 1500 mAh
- Heating time approx. 15 sec
- Incl. 5 glue sticks 150 x Ø 7 mm
- Integrated work light
- automatic shutdown
- Incl. Plug-in power supply

Pistola de pegamento caliente inalámbrica de 3,6 V

- pega papel, cartón, plástico, madera, Cuero, textiles, cerámica, porcelana, Vidrio, piedra, metal, etc.
- Batería de iones de litio de 3,6 V, 1500 mAh
- Tiempo de calentamiento aprox. 15 seg.
- Incl. 5 barras de pegamento 150 x Ø 7 mm
- Luz de trabajo integrada
- apagado automático
- Incl. Fuente de alimentación enchufable

Art.Nr	EAN-Nummer	Gewicht	VPE	Art
17220	40 03315 71727 0	0,557 kg	20	Koffer

**Akku Nass- und Trockensauger
mit 2 AH Li-Ion Batterie**

- Li-Ionen Akku 20V, 2,0 Ah
- ideal für den mobilen Gebrauch
- entfernt Grobschmutz und Feinstaub mit Trocken- und Nasssaugfunktion mit 1,5 A Schnellladegerät
- konstante Saugleistung und Gebläsefunktion
- Edelstahlbehälter 25l

Zubehör:

- 2 AH Li-Ion Batterie
- 1,5 A Schnellladegerät
- 1,5 m Kunststoffschlauch
- 3-teiliges Saugrohr
- 1 Stk. Nass- und Trockenbodenbürste
- 1 Stk. Sofabürste
- 1 Stk. Schaumstofffilter
- 3 Stk. Papierfilterbeutel
- Edelstahlbehälter 25l

2 AH Li-battery wet and dry vacuum cleaner with 25 l container

Aspirador en seco y húmedo con batería de litio 2 AH con depósito de 25l



Art.Nr	EAN-Nummer	Gewicht	VPE	Art
12755	40 03315 84764 9	6,400 kg	1	Karton

Nass- und Trockensauger 1200W

- entfernt Grobschmutz und Feinstaub mit Trocken- und Nasssaugfunktion
- 230 V~/ 50 Hz
- Große Reichweite durch 3,5m Netzkabel
- 30L Edelstahlbehälter
- konstante Saugleistung und Gebläsefunktion
- Luftstromregulierung am Griff
- Zweiteiliges Saugrohr
- Saugleistung 16 kPa
- Kippsicher durch breites Fahrgestell und große Räder
- Zubehör- Aufbewahrung am Fahrgestell



Zubehör:

- 1 St. Permanent-Filter
- 1 St. Schaumstofffilter
- 1 St. Papierfiltertüte
- 1 St. Bodendüse
- 1 St. Fugendüse
- 1 St. Polsterdüse
- 2 St. Saugrohre
- 1 St. flexibler Saugschlauch



Wet and dry vacuum cleaner 1200W

Aspirador en seco y húmedo 1200W

Art.Nr	EAN-Nummer	Gewicht	VPE	Art
12745	40 03315 84783 0	5,500 kg	1	Karton

Trockensauger 1200W

- 230 V-/ 50 Hz
- extra hohe Saugleistung, 20 kPa
- entfernt Grobschmutz und Feinstaub
- konstante Saugleistung und Gebläsefunktion zum Erreichen schwer zugänglicher Stellen
- kompakte Größe und bedienfreundlich

Zubehör:

- 4 m Kabel
- 1,5 m Kunststoffschauch
- 2-teiliges Saugrohr
- 1 Stk. Bodenbürste
- 1 Stk. Rundbürste
- 1 Stk. Spaltdüse
- 1 Stk. Permanentfilterbeutel
- 3 Stk. Papierfilterbeutel

1200 W dry vacuum cleaner with 25 l container

Aspirador en seco de 1200 W con depósito de 25l

Zubehör



Gebläsefunktion



Art.Nr	EAN-Nummer	Gewicht	VPE	Art
12750	40 03315 84761 8	5,500 kg	1	Karton

4 Heimwerker-Werkzeugmaschinen mit umfangreichem Zubehör

500 watt



Elektronik - Schlagbohrmaschine

- Ø 13 mm Bohrfutter
- Umschaltbarer Rechts-/ Linkslauf
- Drehzahl stufenlos regelbar von 0 - 3000 min⁻¹
- Verstellbarer Zweithandgriff mit Tiefenanschlag



230-240V
~50 Hz



500 W



28.000 min⁻¹



Ø 1 - 13 mm



0 - 3000 min⁻¹



Bithalter

350 watt



Stichsäge

- Hubzahl stufenlos einstellbar
- Anschluss für Staubfangsack oder Staubsauger



230-240V
~50 Hz



350 W

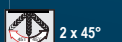

2 x 45°



max. 55 mm



0 - 3.000 min⁻¹



max. 6 mm

150 watt



Elektro - Schwingschleifer

- Staubabsaugung durch gelochte Bodenplatte
- Anschluss für Staubfangsack



230-240V
~50 Hz



150 W



11.000 min⁻¹

187 mm

90 mm

500 watt



Einhand - Winkelschleifer

- Einfacher Scheibenwechsel durch Spindelarretierung
- Verstellbare Schutzhaube
- Zusatzhandgriff rechts oder links anschraubbar



230V-50 Hz



500 W



11.000 min⁻¹



M 14



Ø 115 mm

**Ideal
für den mobilen
Einsatz**



Inhalt

- 1 x Elektronik-Schlagbohrmaschine
- 3 x Steinbohrer
- 3 x Holzbohrer
- 3 x HSS-Bohrer
- 4 x Korund-Schleifstift
- 6 x Bits
- 1 x Bithalter

- 1 x Stichsäge
- 2 x Sägeblatt

- 1 x Elektro-Schwingschleifer
- 5 x Schleifpapier

- 1 x Einhand-Winkelschleifer
- 1 x Schruppscheibe Ø 115 mm

4-pcs. Power tool kit. TÜV / GS + CE approved
in carrying case with wide range of accessories

Juego de 4 máquinas eléctricas, con homologación
TÜV / GS + CE, en maletín con un amplio surtido de accesorios

Art.Nr	EAN-Nummer	Gewicht	VPE	Art
12555	40 03315 70115 6	9,200 kg	2	Koffer



36-tlg. Werkzeugsatz
mit Elektronik- Bohrmaschine

Elektronische Drehzahlregulierung
Umschaltbarer Rechts-/Linkslauf
Verstellbarer Handgriff und Tiefenanschlag
Inhalt:

- 6 Spiralbohrer 3 • 4 • 5 • 6 • 8 • 10mm
- 3 Steinbohrer 6 • 8 • 10mm
- 6 Holzbohrer 3 • 4 • 5 • 6 • 8 • 10mm
- 2 Glasbohrer 6•8mm
- 9 Bits
- 1 Adapter für 6,3 mm (1/4") Steckschlüsseleinsätze
- 1 Sägebogen 150 mm
- 1 Kombizange 160 mm
- 1 Wasserwaage 150 mm
- 1 Universalmesser
- 1 Schraubgriff für Bits
- 1 Bandmaß 3m
- 1 Rollgabelschlüssel 200 mm
- 1 Schlosserhammer 300g
- 1 Kleinteilesortiment (60-tlg.)

36-pcs. Tool set with
electronic impact drill 750 W

36 piezas Juego de herramientas con
taladro de impacto electrónico



750 W



230 V~50 Hz



750 W



0 - 3.000 min⁻¹



Ø 13 mm

Art.Nr	EAN-Nummer	Gewicht	VPE	Art
12615	40 03315 84648 2	5,200 kg	4	Koffer

XC-1 Pro Serie

1500 W

Elektronik-Bohrhammer

3 Funktionen - Bohren • Schlagbohren • Meißeln

- Bohrfutteraufnahme SDS- Plus
- Verstellbare Meißelposition
- Verstellbarer Handgriff und Tiefenanschlag
- Inkl. 3 Bohrer 8 • 10 • 12 mm
1 Flachmeißel
1 Spitzmeißel
Tiefenanschlag
Zusatzhandgriff
Staubfänger



Electronic hammer drill 1500 W

3 functions - drilling • hammer drilling • chiselling

- SDS-Plus drill chuck holder
- Adjustable chisel position
- Adjustable handle and depth stop
- Including 3 drill bits 8 • 10 • 12 mm
1 flat chisel
1 pointed chisel
Depth stop
Additional handle
Dust catcher

Taladro percutor electrónico 1500 W

3 funciones: taladrar • taladrar con percusión • cincelar

- Portabrocas SDS-Plus
- Posición del cincel ajustable
- Mango ajustable y tope de profundidad
- Incluye 3 brocas 8 • 10 • 12 mm
1 cincel plano
1 cincel puntiagudo
Parada de profundidad
Asa adicional
Colector de polvo



1.500 W



0 - 800 min⁻¹



230 V~ / 50 Hz



SDS-plus



0 - 800 min⁻¹

Art.Nr	EAN-Nummer	Gewicht	VPE	Art
12598	40 03315 84837 0	7,000 kg	2	Koffer

900 W



Bohr- und Meißelhammer

- 3 Funktionen:
Bohren,
Schlagbohren,
Meißeln
- Lieferumfang:
Bohr- und Meißelhammer 900 W,
3 SDS-Bohrer – Ø 8 · 10 · 12 mm,
1 SDS-Spitzmeißel,
1 SDS-Flachmeißel,
1 Staubfang-Kappe
und 1 Tiefenanschlag
- **Komplett im praktischen
Aufbewahrungskoffer**



Hammer drill and chisel hammer

- 3 functions:
Drill, Hammer drilling, Chisel
- Scope of delivery:
Hammer drill and chisel hammer 900 W,
3 SDS drills - Ø 8 10 12 mm,
1 SDS pointed chisel,
1 SDS flat chisel,
1 dust cap
and 1 depth stop
- **Complete in a practical storage case**

Taladro percutor y martillo cincel

- 3 funciones:
Taladro, Perforación de martillo, Cincel
- Volumen de suministro:
Martillo perforador y cincelador 900 W,
3 brocas SDS - Ø 8 10 12 mm,
1 cincel puntiagudo SDS,
1 cincel plano SDS,
1 tapón antipolvo
y 1 tope de profundidad
- Martillo perforador y cincelador 900 W**



900 W

4000 min⁻¹

230 V~/ 50 Hz

SDS-plus

800 min⁻¹

Art.Nr	EAN-Nummer	Gewicht	VPE	Art
12591	40 03315 71611 2	6.780 kg	3	Koffer

XC-1 Pro Serie

Elektro- Bohrschrauber
mit 23 Drehmomenteinstellungen + 1 Stufe „Bohren“

- Drehzahl von 0 - 850 min-1
stufenlos elektronisch regelbar
- Rechts- / Linkslauf
- Ø 10 mm Schnellspann-Bohrfutter
- Anti-Slip Griff

Electric drill / driver
with 23 torque settings + 1 stage „drilling“

- Speed from 0 - 850 min-1
continuously electronically adjustable
- Right / left rotation
- Ø 10 mm quick release drill chuck
- Anti-slip handle

Taladro / destornillador eléctrico
con 23 ajustes de par + 1 etapa de „perforación“

- Velocidad de 0 a 850 min-1
infinitamente variable electrónicamente
- Rotación derecha / izquierda
- Portabrocas de liberación rápida de Ø 10 mm
- Mango antideslizante



300 W



BRÜDER
MANESMANN
WERKZEUGE GMBH

1. Platz
PREIS / LEISTUNG
IN DER KATEGORIE
BOHRMASCHINEN &
-HAMMER



Art.Nr	EAN-Nummer	Gewicht	VPE	Art
12502	40 03315 84577 5	1,475 kg	5	Karton

Notizen

Elektronik-Schlagbohrmaschine

- Umstellbar von Bohren auf Schlagbohren
- Drehzahl von 0 – 2800 min⁻¹ stufenlos voreinstellbar
- Bohrfutteraufnahme Ø 1,5 – 13 mm
- Umschaltbarer Rechts-/Linkslauf
- Verstellbarer Handgriff und Tiefenanschlag
- Kontrollleuchte für Kohlebürstenverschleiß

Electronic percussion drill

- Selectable boring or impact boring
- Smoothly pre-settable number of revolutions between 0 - 2800 min⁻¹
- Ø 1.5 - 13 mm drill chuck fitting attachment
- Adjustable hand grip and depth stop
- Reversible right/left hand motion
- Control light for carbon brush conductor wear

Taladro electrónico de percusión

- Adaptable de taladro a taladro de percusión
- Número de revoluciones con preajuste progresivo de 0 – 2800 min⁻¹
- Alojamiento de portabrocas de Ø 1,5 – 13 mm
- Asa regulable y guía de profundidad
- Conmuta entre rotación hacia la derecha / izquierda
- Luces de control para el desgaste de las escobillas de carbón



1100 W

Kontrollleuchte für Kohlebürstenverschleiß

Art.Nr	EAN-Nummer	Gewicht	VPE	Art
12545	40 03315 71037 0	3,200 kg	6	Karton

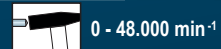

BRÜDER
MANESMANN
WERKZEUGE GMBH

1. Platz
PREIS / LEISTUNG
IN DER KATEGORIE
BOHRMASCHINEN &
-HÄMMER

Elektronische Schlagbohrmaschine

- Umstellbar von Bohren auf Schlagbohren
- Drehzahl von 0 – 3000 min⁻¹ stufenlos voreinstellbar
- Umschaltbarer Rechts- / Linkslauf
- Bohrfutteraufnahme Ø 13 mm
- Verstellbarem Handgriff mit Tiefenanschlag

Electronic percussion drill

- Selectable boring or impact boring
- Smoothly pre-settable number of revolutions between 0 – 3000 min⁻¹
- Ø 13 mm drill chuck fitting attachment
- Adjustable hand grip and depth stop
- Reversible right/left hand motion

Taladro electrónico de percusión

- Adaptable de taladro a taladro de percusión
- Número de revoluciones con preajuste progresivo de 0 – 3000 min⁻¹
- Alojamiento de portabrocas de Ø 13 mm
- Asa regulable y guía de profundidad
- Conmuta entre rotación hacia la derecha / izquierda



650 W

Art.Nr	EAN-Nummer	Gewicht	VPE	Art
12507	40 03315 70038 8	1,800 kg	6	Karton

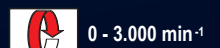

500 W

XP-1 Pro Serie



Schleifscheibe ist nicht im Lieferumfang enthalten. • Disco amolado no incluido! • Grinding disc is not included • Slijpschijf is niet bijgevoegt! • Meule non incluse! La mola per macinare non è compresa nella dotazione. • Brusni Kotač nije dio isporuke.



500 W



11.000 U/min



230 - 240 V~/50 Hz



Ø 115 mm • M14

Einhand Winkelschleifer Ø 115 mm

- Einfacher Scheibenwechsel durch Spindelarrretierung
- Verstellbare Schutzhaube
- Zusatzhandgriff an 2 Positionen anschraubbar

Angle Grinder Ø 115 mm

Esmeriladora Angular Ø 115 mm

Art.Nr	EAN-Nummer	Gewicht	VPE	Art
12175	40 03315 84750 2	1,600 kg	6	Karton

900 W

XP-1 Pro Serie



Schleifscheibe ist nicht im Lieferumfang enthalten. • Disco amolado no incluido! • Grinding disc is not included • Slijpschijf is niet bijgevoegt! • Meule non incluse! La mola per macinare non è compresa nella dotazione. • Brusni Kotač nije dio isporuke.



900 W



11.000 U/min



230 - 240 V~/50 Hz



Ø 125 mm • M14

Einhand Winkelschleifer Ø 125 mm

- Einfacher Scheibenwechsel durch Spindelarrretierung
- Verstellbare Schutzhaube mit Schnellmontagesystem
- Zusatzhandgriff an 3 Positionen anschraubbar

Angle Grinder Ø 125 mm

Esmeriladora Angular Ø 125 mm

Art.Nr	EAN-Nummer	Gewicht	VPE	Art
12177	40 03315 84753 3	2,25 kg	6	Karton



XP-1 Pro Serie

Winkelschleifer Ø 230 mm

- Einfacher Scheibenwechsel durch Spindelarreterung
- Zusatzhandgriff an 3 Positionen anschraubbar
- Anlaufstrombegrenzung
- Verstellbare Schutzhaube

Angle Grinder Ø 230 mm

Esmeriladora Angular Ø 230 mm



2000 W

Schleifscheibe ist nicht im Lieferumfang enthalten. • Disco amolado no incluido! • Grinding disc is not included • Slijpschijf is niet bijgevoegt! • Meule non incluse! La mola per macinare non è compresa nella dotazione. • Brusni Kotač nije dio isporuke.



230 - 240 V~ / 50 Hz



2000 W



Ø 230 mm • M14



6.500 U/min

Art.Nr	EAN-Nummer	Gewicht	VPE	Art
12179	40 03315 84950 6	6,700 kg	2	Karton

Elektronik-Pendelhub-Stichsäge mit Laserstrahl-Schnittführung

- 4-fach einstellbarer Pendelhub
- Hubzahl über Stellrad stufenlos einstellbar
- Neigbarer Sägeschuh von 45° bis -45°
- Laserstrahl zeigt die Schnittführung an
- Inkl. 3 Sägeblättern (2 x für Holz, 1 x für Metall)
- max. Schnitttiefe in Holz 100 mm
- max. Schnitttiefe in NE - Metall 10 mm

Electronic Pendulum Jigsaw with laser beam

- 4-times adjustable pendulum stroke
- infinitely variable number of strokes
- tiltable base plate from 45° to -45°
- laser beam indicates the cutting line
- incl. 3 sawblades (2 x wood, 1 x metal)
- max. cutting depth in wood: 100 mm
- max. cutting depth in NF-metal: 10 mm

Sierra de calar con indicación de corte laser

- 4 ajustes de carreras de penduleo
- base inclinable de 45° hasta -45°
- regulación del número de carreras sin escalones
- el rayo láser indica la conducción del corte
- incluye 3 hojas de sierra (2 para madera, 1 para metal)
- la profundidad de corte para madera es de 100 mm y para acero NF 10 mm

800 W



800 W



230 V~
50 Hz



max. 100 mm



0 -
3.000 min⁻¹



2 x 45°



Laserklasse 2
Categoria Láser 2
Class 2-Laser product

Art.Nr	EAN-Nummer	Gewicht	VPE	Art
12783	40 03315 71281 7	2,600 kg	8	Karton

1200 W



**Elektro- Handkreissäge
mit Laserstrahl-Schnittführung**

- 1200 Watt
- Parallelanschlag
- Anti Slip Griff
- Spindelarretierung
- Einstellbare Schnitttiefe
- Gehrungsschnitte 0° bis 45°
- HM - Sägeblatt (185 x 20 x 24T)
- Vorrichtung zur Staubabsaugung
- Laserstrahl zeigt die Schnittführung an
- Batterien für Lasereinheit (2 x LR44)
nicht im Lieferumfang enthalten

**Electric circular saw
with laser beam cutting guide**







- 1200 watts
- Rip fence
- Anti slip grip
- Spindle lock
- Adjustable cutting depth
- Miter cuts 0° to 45°
- HM - saw blade (185 x 20 x 24T)
- Device for dust extraction
- The laser beam shows the cutting line
- Batteries for laser unit (2 x LR44)
not included in the delivery

**Sierra circular eléctrica
con guía de corte por rayo láser**

- 1200 vatios
- Valla cortafuegos
- Agarre antideslizante
- Bloqueo del eje
- Profundidad de corte ajustable
- Cortes a inglete de 0° a 45°
- HM - hoja de sierra (185 x 20 x 24T)
- Dispositivo para extracción de polvo
- El rayo láser muestra la línea de corte
- Baterías para unidad láser (2 x LR44)
no incluido en la entrega



Laserklasse 2
Categoría Láser 2
Class 2-Laser product

	185 x 20 x 24 T
	230V~ / 50 Hz
	1200 W
	4800 min ⁻¹
	45° 45mm
	90° 65mm

Handkreissäge		Circular saw		Sierra circular da mano	
Art.Nr	EAN-Nummer	Größe	Gewicht	VPE	Art
12795	40 03315 70555 0	Ø 185 x 20 x 24 Z	5,000 kg	4	Karton

XP-1 Pro Serie

1200 W



Elektro- Handkreissäge mit Laserstrahl-Schnittführung

- 1200 Watt
- Parallelanschlag
- Anti Slip Griff
- Spindelarreterung
- Einstellbare Schnitttiefe
- Gehrungsschnitte 0° bis 45°
- HM - Sägeblatt (185 x 20 x 24T)
- Vorrichtung zur Staubabsaugung
- Laserstrahl zeigt die Schnittführung
- Batterien für Lasereinheit (2xAAA) nicht im Lieferumfang enthalten

Electric circular saw with laser beam cutting guide







- 1200 watts
- Rip fence
- Anti slip grip
- Spindle lock
- Adjustable cutting depth
- Miter cuts 0° to 45°
- HM - saw blade (185 x 20 x 24T)
- Device for dust extraction
- The laser beam shows the cutting line
- Batteries for laser unit (2xAAA) not included in the delivery

Sierra circular eléctrica con guía de corte por rayo láser

- 1200 vatios
- Valla cortafuegos
- Agarre antideslizante
- Bloqueo del eje
- Profundidad de corte ajustable
- Cortes a inglete de 0° a 45°
- HM - hoja de sierra (185 x 20 x 24T)
- Dispositivo para extracción de polvo
- El rayo láser muestra la línea de corte
- Baterías para unidad láser (2xAAA) no incluido en la entrega



Laserklasse 2
Categoría Láser 2
Class 2-Laser product

	185 x 20 x 24 T
	230V~ / 50 Hz
	1200 W
	4500 min ⁻¹
	45° 42mm
	90° 64mm

Handkreissäge • Circular saw • Sierra circular da mano					
Art.Nr	EAN-Nummer	Größe	Gewicht	VPE	Art
12797	40 03315 84879 0	Ø 185 x 20 x 24 Z	4,500 kg	2	Karton

Mini-Handkreissäge 600 W
mit 3 Sägeblättern

- HM- Kreissägeblatt, Ø 85 x Ø 10 x 30 Z
- HSS- Kreissägeblatt, Ø 85 x Ø 10 x 36 Z
- Diamant- Trennscheibe, Ø 85 x Ø 10 x 2
- Stufenlos einstellbare Schnitttiefe bis 25 mm
- Softgrip
- Staubabsaugvorrichtung
- Parallelanschlag

Mini circular saw

Sierra circular



600 W

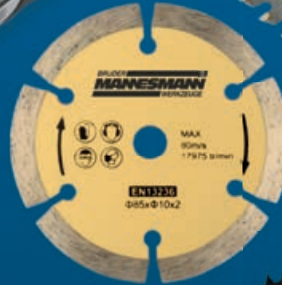

600 W



230-240 V~ / 50Hz



7400 min⁻¹



Bohrung 10 mm

Art.Nr	EAN-Nummer	Gewicht	VPE	Art
12891	40 03315 71698 3	2,350 kg	4	Karton

Ersatz Sägeblättern für Mini-Handkreissäge Art.-Nr.:12891

- HM- Kreissägeblatt, Ø 85 x Ø 10 x 30 Z
- HSS- Kreissägeblatt, Ø 85 x Ø 10 x 36 Z
- Diamant- Trennscheibe, Ø 85 x Ø 10 x 2

Mini circular saw

Sierra circular



Art.Nr	EAN-Nummer	Gewicht	VPE	Art
12892	40 03315 717121 6	0,135 kg	5	Karton

Alu- Führungsschiene für Mini- Handkreissäge

- 3 Aluminiumschienen, Länge jeweils 42 cm, kombinierbar zu max. 126 cm Gesamtlänge
- Für präzise gerade und lange Schnitte
- Moosgummi Auflage verhindert Verrutschen und Verkratzen des Werkstücks
- Splitterschutz aus Hartgummi

Inhalt:

- 3 Aluminiumschienen, a 42 cm
- 2 Verbindungsleiste
- 1 Stiftschlüssel
- 2 Schraubzwingen

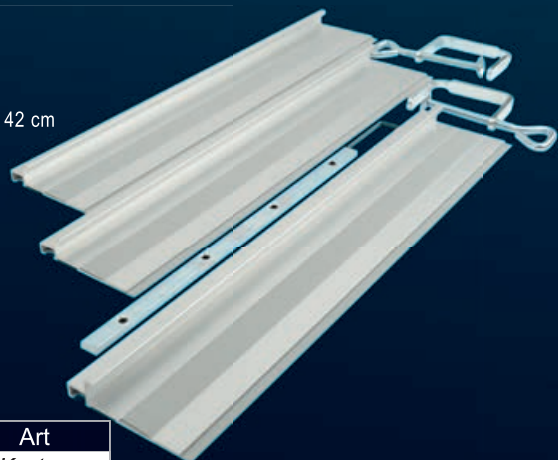

Aluminum guide rail for mini circular saw

Carril guía de aluminio para mini sierra circular

Art.Nr	EAN-Nummer	Gewicht	VPE	Art
12893	40 03315 71729 4	1,580 kg	12	Karton

Elektrohobel

- Kompakte, robuste Ausführung
- Hobelschuh mit V-Nut zum Anfasen
- mit Seitenanschlag und Falztiefenanschlag
- Wendehobelmesser, Hobelbreite: 82 mm
- stufenlose Spantiefeneinstellung bis 2 mm
- incl. Spänefangsack

Electric planer

- solid, sturdy execution
- base plate with V-shaped channel for bevelling
- with side stop and depth - stop
- planing knife, planing width 82 mm
- depth of shaving 0 - 2 mm (infinitely)
- incl. dust collection bag

Cepillo eléctrico

- ejecución compacta y robusta
- placa de base con ranura prismática para biselar
- tope lateral y tope profundidad
- recepción de viruta 2 mm sin escalones ancho de cepillo 82 mm
- incluye saco para el aserrín

710 W



Art.Nr	EAN-Nummer	Gewicht	VPE	Art
12870	40 03315 70494 2	2,500 kg	3	Karton
Wendemesser (Paar) • Spare blade • Disco de fresaje				
12863	40 03315 70632 8	0,060 kg	5	Karte



Flachdübelfräse

- zum Fräsen von Nuten für Flachdübelverbindungen in Massivholz, Spanplatten, Sperrholz und Faserplatten
- schwenkbar von 0 - 135°, max. Nuttiefe 19 mm, Nutbreite 3,5 mm
- Spindelarretierung für einfachen Fräserwechsel
- mit Staubfangsack

Biscuit Jointer

- for milling of slits in wood, chip board ply wood and fiber plates
- adjustable from 0 - 135°, max. milling depth 19 mm, milling width 3,5 mm
- spindle locking
- with dust collection bag

Fresadora de ranuras

- para fresar ranuras para juntas de clavijas planas en madera de maziza, tablero de virutas, madera contrachapada y plancha de fibras
- girable de 0 - 135°, profundidad máxima de ranura 19 mm, anchura máxima 3,5 mm
- husillo de retención para un fácil cambio de fresas
- con recipiente de recogida para el polvo

900 W

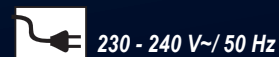

Art.Nr	EAN-Nummer	Gewicht	VPE	Art
12862	40 03315 70360 0	3,500 kg	4	Koffer
Ersatz Frässscheibe • Spare disc • Disco de fresaje				
12863	40 03315 70632 8	1,200 kg	5	Karte

XP-1 Pro Serie

Elektro Schwingschleifer

mit Staubfangkassette und Filter

- Staubabsaugung durch gelochte Schleifplatte
- Staubfangkassette mit Filter
- Einstellbare Hubzahl

Finishing sander

Lijadora vibratoria



230 V~50 Hz



250 W

187 mm



90 mm



14.000 -

24.000 min⁻¹

250 W



Art.Nr	EAN-Nummer	Gewicht	VPE	Art
12335	40 03315 84892 9	1,800 kg	4	Karton

Elektro - Schwingschleifer

- Staubabsaugung durch gelochte Schleifplatte
- Anschluss für Staubfangsack
- Einstellbare Hubzahl 6.000 - 11.000 min⁻¹

Finishing sander

- dust-extraction through punched grinding plate
- connection for vacuum cleaner
- adjustable speed 6.000 - 11.000 min⁻¹

Lijadora vibratoria

- aspiración del polvo por los agujeros de la placa de base
- conexión para el recipiente de polvo o aspiradora
- regulación del número de vibraciones 6.000 - 11.000 min⁻¹



230 V~50 Hz



200 W

187 mm



90 mm



6.000 -

11.000 min⁻¹

200 W



Art.Nr	EAN-Nummer	Gewicht	VPE	Art
12333	40 03315 71282 4	1,600 kg	4	Karton

Schwingschleifer

- Staubabsaugung durch gelochte Schleifplatte
- Anschluss für Staubfangsack oder Staubsauger

Finishing sander

- with vacuum-cleaner through basic plate
- connection for dust container or vacuum cleaner

Lijadora vibratoria eléctrica

- aspiración del polvo por los agujeros de la placa de base
- conexión para el recipiente de polvo o aspiradora



230 V~50 Hz



150 W

187 mm



90 mm



10.000 min⁻¹

150 W



Art.Nr	EAN-Nummer	Gewicht	VPE	Art
12330	40 03315 705499	1,290 kg	6	Karton

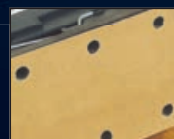

XP-1 Pro Serie

Elektro- Exenterschleifer
mit Staubfangkassette

- Drehzahl von 7.000 - 13.000 min⁻¹
- Staubabsaugung durch gelochte Schleifplatte
- Anti-Slip Griff

380 W

Electric random orbit sander with dust trap cassette

Lijadora de órbita aleatoria eléctrica
con cassette colector de polvo



230 - 240 V~/ 50 Hz



7.000 - 13.000 U/min



380 W



Ø 125 mm

Art.Nr	EAN-Nummer	Gewicht	VPE	Art
12345	40 03315 84895 0	1,600 kg	4	Karton



XC-1 Pro Serie

Elektro- Bandschleifer
mit Staubfangkassette

- Anti-Slip Griff
- inkl. Klemmen für stationäre Montage

Electric belt sander with dust collector

- Anti-slip handle
- Including clamps for stationary installation

Lijadora de banda eléctrica con colector de polvo

- Mango antideslizante
- Incluye abrazaderas para instalación estacionaria



230 - 240 V~/ 50 Hz



600 W



170 - 250 U/min



75 - 150 mm



75 - 457 mm

Art.Nr	EAN-Nummer	Gewicht	VPE	Art
12360	40 03315 84848 6	3,800 kg	4	Karton



120 W



LpA= 67 dB (A)

Art.Nr	EAN-Nummer	Gewicht	VPE	Art
1225-125	40 03315 06975 1	6,000 kg	1	Karton

Doppelschleifmaschine

- leistungsstarkes Kompakt-Gerät
- ruhiger, vibrationsfreier Lauf
- stabile Werkzeugauflagen, verstellbarer Funkenschutz
- incl. je 1 x Schleifscheibe grob/fein

Double Bench Grinder

- strong and compact
- smooth, vibrations-free running
- stable tool support, adjustable spark protection
- incl. each one grinding disc, coarse / fine

Máquina afiladora

- aparato compacto de alta potencia
- funcionamiento silencioso y libre de vibración
- base de herramientas estable, protección de chispas regulable
- incluye un disco esmeril fino y un disco esmeril grueso

200 W

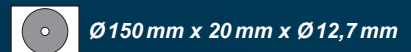

LpA= 67 dB (A)

Art.Nr	EAN-Nummer	Gewicht	VPE	Art
1225-150	40 03315 06936 2	6,000 kg	1	Karton

Doppelschleifmaschine

- leistungsstarkes Kompakt-Gerät
- ruhiger, vibrationsfreier Lauf
- stabile Werkzeugauflagen, verstellbarer Funkenschutz
- incl. je 1 x Schleifscheibe grob/fein

Double Bench Grinder

- strong and compact
- smooth, vibrations-free running
- stable tool support, adjustable spark protection
- incl. each one grinding disc, coarse / fine

Máquina afiladora

- aparato compacto de alta potencia
- funcionamiento silencioso y libre de vibración
- base de herramientas estable, protección de chispas regulable
- incluye un disco esmeril fino y un disco esmeril grueso

350 W



LpA= 67 dB (A)

Art.Nr	EAN-Nummer	Gewicht	VPE	Art
1225-200	40 03315 06995 9	17,500 kg	1	Karton

Doppelschleifmaschine

- leistungsstarkes Kompakt-Gerät
- ruhiger, vibrationsfreier Lauf
- stabile Werkzeugauflagen, verstellbarer Funkenschutz
- incl. je 1 x Schleifscheibe grob/fein

Double Bench Grinder

- strong and compact
- smooth, vibrations-free running
- stable tool support, adjustable spark protection
- incl. each one grinding disc, coarse / fine

Máquina afiladora

- aparato compacto de alta potencia
- funcionamiento silencioso y libre de vibración
- base de herramientas estable, protección de chispas regulable
- incluye un disco esmeril fino y un disco esmeril grueso

XP-1 Pro Serie

Elektrische Oberfräse mit 6 Fräsern

- einstellbarer Tiefenanschlag
- Spindelarretierung für einfachen Fräserwechsel
- 6 x Fräser Ø 6 mm
- 2 x Spannzange 6 + 8 mm
- 1 x Parallelanschlag
- 1 x Zirkelspitze
- 1 x Kopierhülse
- 1 x Vorrichtung zur Staubabsaugung



Electric router with 6 cutters

Fresadora eléctrica con 6 cortadores



1200 W



16.000 -
30.000 U/min



230 - 240 V~/ 50 Hz

Art.Nr	EAN-Nummer	Gewicht	VPE	Art
12868	40 03315 84876 9	3,800 kg	4	Karton

Elektrotacker

- verarbeitet Klammern und Nägel
- stufenlose Schlagkräfteeinstellung
- 100 Klammern und 100 Nägel im Lieferumfang enthalten

Electric staple gun

- Suitable for staples and nails
- Adjustable impact power
- 100 pcs. each of staples and nails included

Grapadora eléctrica

- Funciona con grapas y clavos
- Fuerza de percusión ajustable de forma gradual
- 100 grapas y 100 clavos incluidos en el volumen de suministro

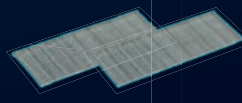
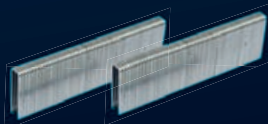

Art.Nr	EAN-Nummer	Gewicht	VPE	Art
12420	40 03315 71595 5	1,750	5	Karton



135 W

Compact-Tool

- Der Alleskönner zum Bohren, Schleifen, Fräsen, Trennen und Polieren
- Umfangreiches 50-tlg. Zubehör
- Stufenlos einstellbare Drehzahl
- 135 Watt Spitzenleistung
- Universell einsetzbar für unterschiedliche Materialien
- Komplett im praktischen Aufbewahrungskoffer



230 V~ 50 Hz



135 W



8.000 - 30.000 min⁻¹



Art.Nr	EAN-Nummer	Gewicht	VPE	Art
92577	40 03315 70779 0	1.300 kg	6	Koffer

130 W

Mini Grinder – Compact Tool

- the ALLROUND tool for drilling, grinding, milling, cutting, and polishing
- with 50 pcs. accessories
- infinitely variable speed
- 135 W max. capacity
- complete in practical carry-case



Herramienta multiuso

- multiusable para taladrar, lijar, fresar, segregar y pulir
- amplio surtido de 50 accesorios
- potencia máxima 135 vatios
- utilización universal para diferentes materiales
- revoluciones por minuto graduable sin escalones
- todo completo en un maletín práctico



230 V~ 50 Hz



130 W



8.000 - 30.000 min⁻¹



Art.Nr	EAN-Nummer	Gewicht	VPE	Art
92575	40 03315 70658 8	1.000 kg	6	Koffer

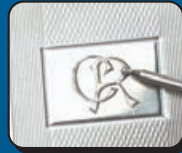

80-tlg. Hobby Tool Kit mit Stativ und biegsamer Welle

**Der Alleskönner zum Bohren,
Schleifen, Fräsen, Trennen und Polieren**

130 W



Hobby Tool Kit

- Geschwindigkeiten stufenlos einstellbar von 8.000 bis max. 30.000 min⁻¹
- Inklusive Stativ und biegsamer Welle für Arbeiten an schwer zugänglichen Stellen
- Leichter Werkzeugwechsel durch Spindelarretierung.
- Umfangreiche Ausstattung mit 80 Zubehörteilen
- Alle Artikel sicher und übersichtlich im Aufbewahrungskoffer.

Hobby Tool Kit

- infinitely variable speed from 8.000 upto max. 30.000 min r.p.m.
- including support and flexible shaft for working at hardly accessible places
- easy exchange of tools by spindle lock
- important equipment with 80 accessories
- all articles safe and well arranged in carry-case

Hobby Tool Kit

- Velocidad regulable sin esalaciones 8.000 hasta max. 30.000 r.p.m
- Tubo flexible para trabajos en lugares de acceso difícil
- Cambio de herramientas facilitado por detención de husillo
- Equipo copioso con 80 accesorios
- Todos los articulos guardados en maletín con disposición segura y clara

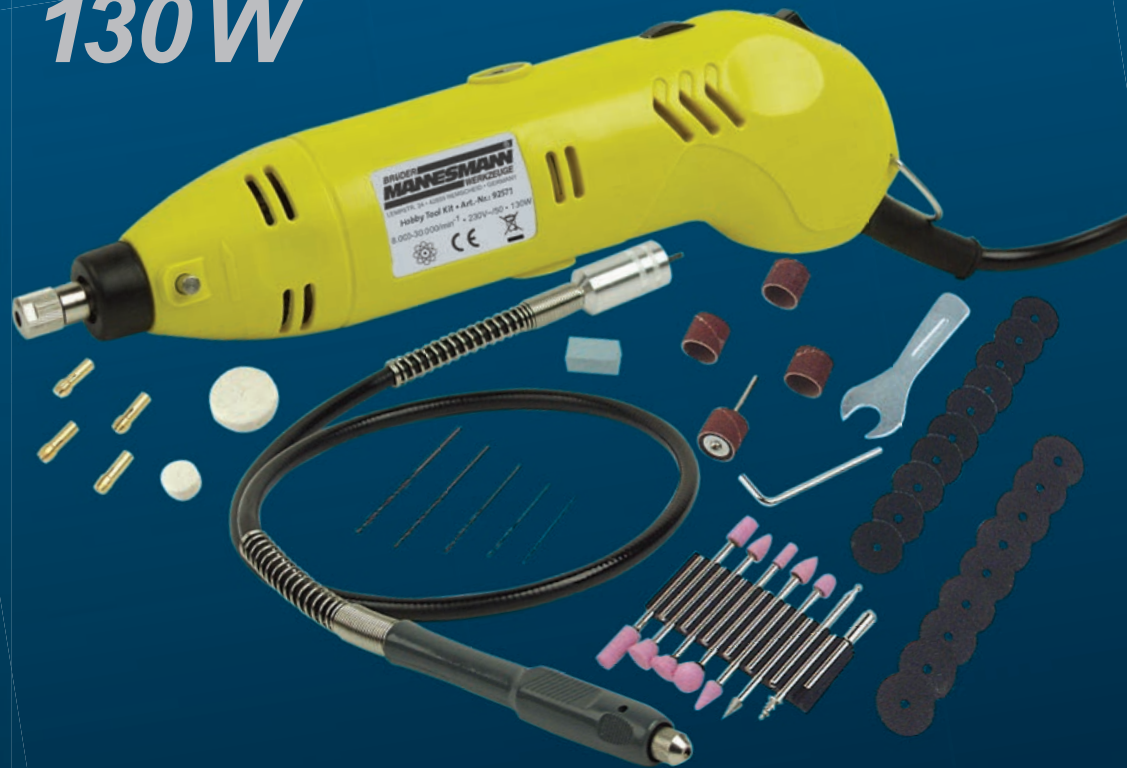

Das Hobby Tool Kit mit seinem umfangreichen Zubehör eröffnet zahlreiche Anwendungsbereiche im Hobby- und Heimwerkerbereich.

Ob zum Gravieren, Polieren, Fräsen, Schneiden, Trennen, Entrostern, Schleifen oder Bohren.

Mit der stufenlos einstellbaren Drehzahl (8.000 bis 30.000 U/min) und den mitgelieferten Aufsatzwerkzeugen bearbeiten Sie unterschiedlichste Materialien.



8.000 - 30.000 min⁻¹



130 W



230 V~ 50 Hz

Art.Nr	EAN-Nummer	Gewicht	VPE	Art
92571	40 03315 70929 9	1.700 kg	6	Koffer

XP-1 Pro Serie

2000 W

Heißluftgebläse 2000 W
mit LCD Temperaturanzeige

- 3-Stufen Heißluftgebläse
- Die LCD Anzeige erlaubt die genaue Temperaturkontrolle, damit Materialien im richtigen Temperaturbereich bearbeitet werden können

3 umschaltbare Temperaturbereiche

I = 50° C • 300 l/min

II = 70° bis 600° C • 300 l/min

III = 70° bis 600° C • 500 l/min

• Inkl. 4 Aufsätzen

1 Punktdüse

1 Breitstrahldüse

1 Kantenschutzdüse

1 Umlenkdüse



Hot Air Gun

Soplador de aire caliente

Art.Nr	EAN-Nummer	Gewicht	VPE	Art
49520	40 03315 84773 1	1,100 kg	10	Karton



230 Volt - 50 Hz



2000 Watt

Heißluftpistole 2000 W

- incl. umfangreichem Zubehör
1 x Punktdüse,
1 x Umlenkdüse
1 x Breitstrahldüse
1 x Kantenschutzdüse
- 2 umschaltbare Temperaturbereiche
Stufe 1 = 300 l/min bei 350° C
Stufe 2 = 500 l/min bei 550° C

Hot Air Gun 2000 W

- incl. wide range of accessories
1 x pointed nozzle,
1 x reversing nozzle
1 x wide angle nozzle,
1 x edge protection nozzle
- 2 adjustable temperature ranges
range 1 = 300 l/min at 350° C
range 2 = 500 l/min at 550° C

Soplador de aire caliente 2000 W

- incluye un amplio surtido de accesorios
1 x tobera de punto,
1 x tobera en forma angular
1 x tobera para chorros anchos
1 x tobera para la protección de esquinas
- 2 zonas de temperaturas ajustables
escalón 1 = 300 l/min a 350° C
escalón 2 = 500 l/min a 550° C

2000 W



Art.Nr	EAN-Nummer	Gewicht	VPE	Art
49500	40 03315 70105 7	0,650 kg	10	Karton



230 Volt - 50 Hz



2000 Watt

1400 W

Farb- und Mörtelrührer

- zum Anmischen flüssiger bis zähflüssiger Baustoffe wie Farben, Mörtel, Kleber, Putze usw.
- ergonomisch geformte Handgriffe
- kraftvoller 1400 Watt Motor für größere Mengen von zähflüssigem Mischgut
- 2 Gang Getriebe mit elektronischer Drehzahlregelung

Paint and mortar mixer

- For mixing liquid and viscous construction materials such as paint, mortar, adhesive, plaster etc.
- Ergonomic handgrips
- Powerful motor for large quantities of viscous mixing materials
- Two-speed gearbox with electronic speed-control

Mezcladora de pintura y mortero

- para mezclar materiales de construcción líquidos y en polvo tales como pinturas, morteros, adhesivos, revoques etc.
- mangos modelados de forma ergonómica
- potente motor para cantidades grandes de mezclas líquidas
- selector de dos velocidades con regulación electrónica



Farb- und Mörtelrührer • Paint and mortar mixer • Mezcladora de pintura mortero

Art.Nr	EAN-Nummer	Gewicht	VPE	Art
12800	40 03315 71138 4	1,400 kg	1	Karton



Rührstab für Farb- und Mörtelmischer • Stirrer rod • Barra agitadora

Art.Nr	EAN-Nummer	Gewicht	VPE	Art
12801	40 03315 71140 7	1,800 kg	1	lose





Elektronik Bohrhammer • Seite 17

BRÜDER MANNESMANN WERKZEUGE GmbH
Lempstraße 24 • 42859 Remscheid
Postfach 160 106 • 42830 Remscheid

Tel.: 0 21 91 / 37 14 - 0

Fax: 0 21 91 / 38 64 77

Export Fax: 0049 - 2191 / 37 14 48

info@Br-MANNESMANN.de

www.Br-MANNESMANN.de

© BRÜDER MANNESMANN WERKZEUGE GMBH 2021

Technische Änderungen vorbehalten. Die Haftung für Druckfehler ist ausgeschlossen.